

Operating Systems and Networks

Network Lecture 3: Link Layer (1)

Adrian Perrig
Network Security Group
ETH Zürich

Pending Issues

- Dis-connect of homework from lecture
- Earlier posting of lecture slides

Where we are in the Course

- Moving on to the Link Layer!

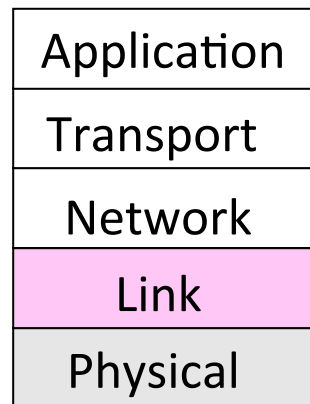

Scope of the Link Layer

- Concerns how to transfer messages over one or more connected links
 - Messages are frames, of limited size
 - Builds on the physical layer

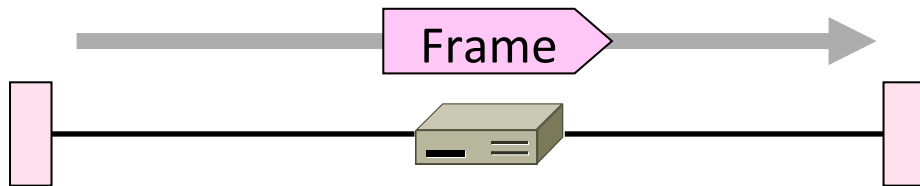

In terms of layers ...

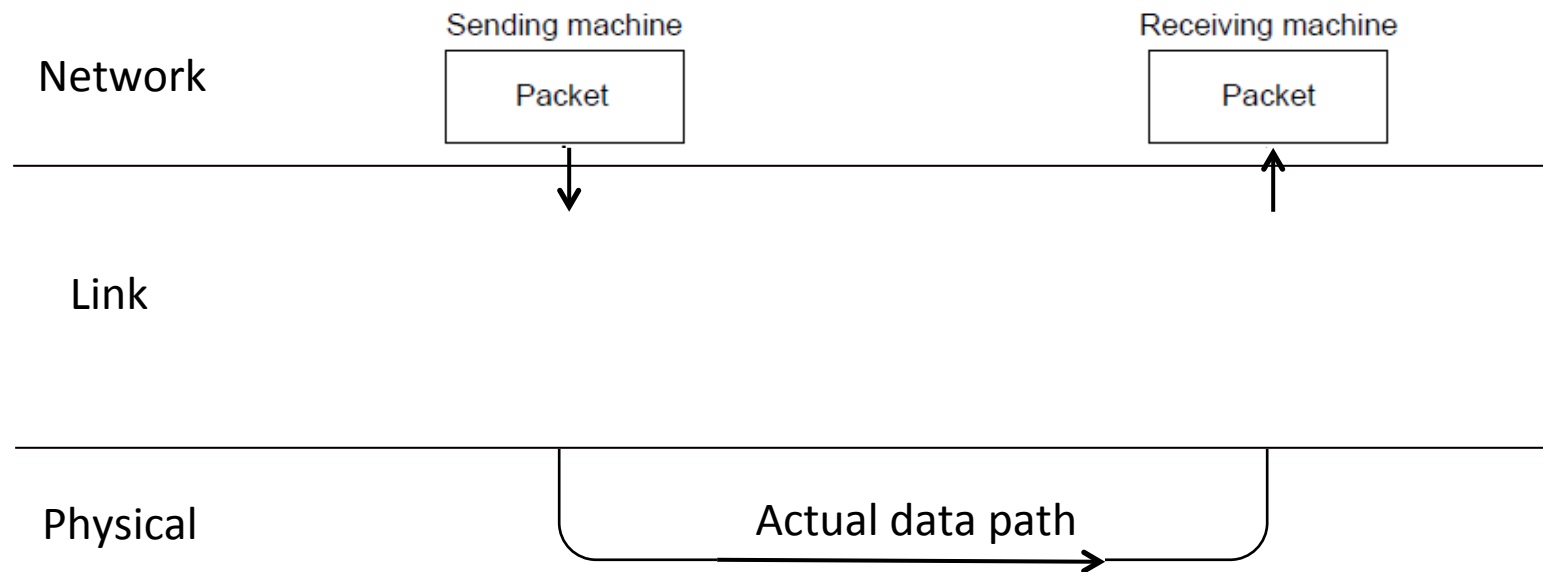

In terms of layers (2)

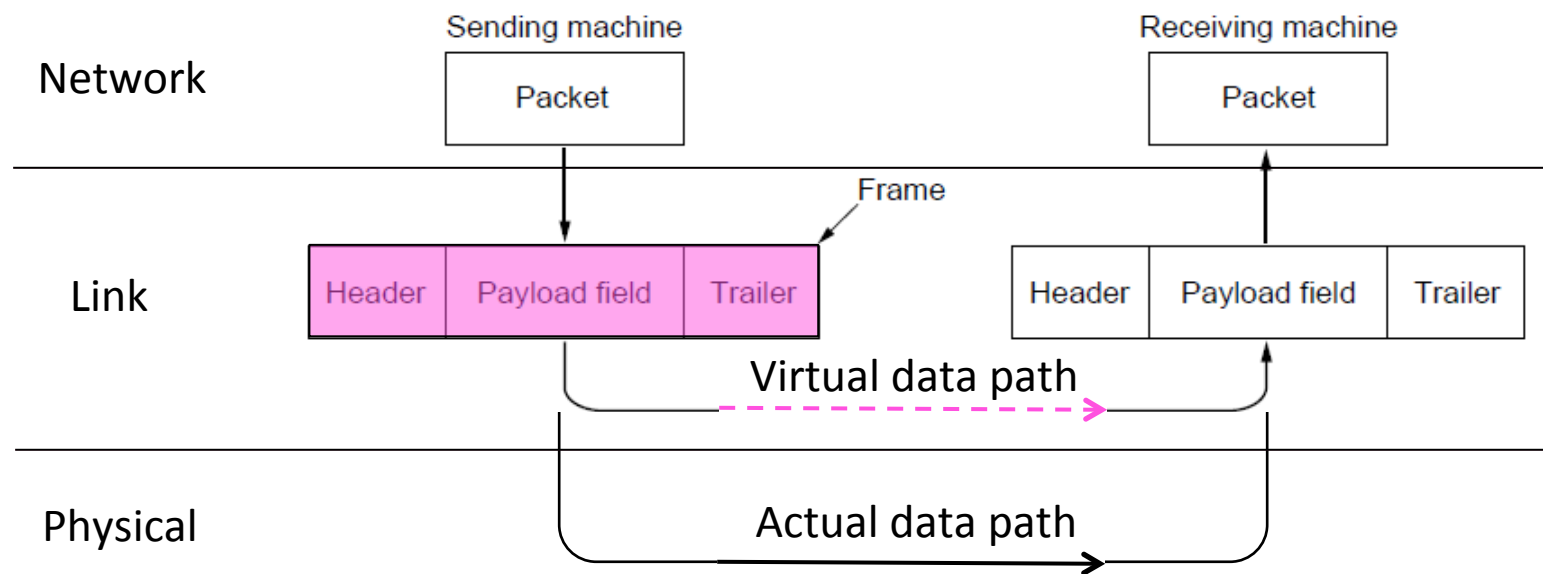

Typical Implementation of Layers

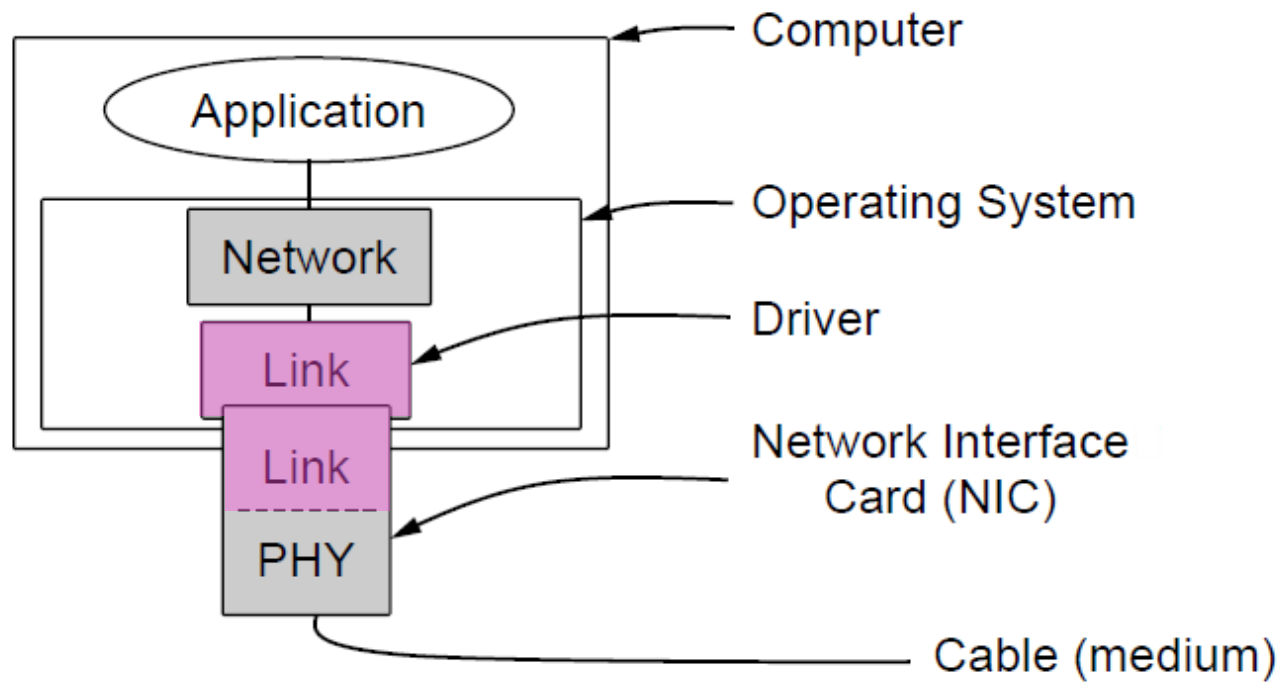

Topics

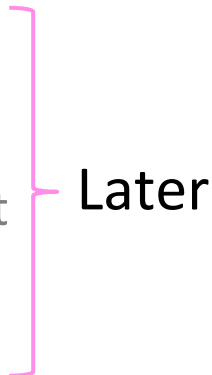
1. Framing
 - Delimiting start/end of frames
 2. Error detection and correction
 - Handling errors
 3. Retransmissions
 - Handling loss
 4. Multiple Access
 - 802.11, classic Ethernet
 5. Switching
 - Modern Ethernet
- 
- Later

Framing (§3.1.2)

- The Physical layer gives us a stream of bits. How do we interpret it as a sequence of frames?

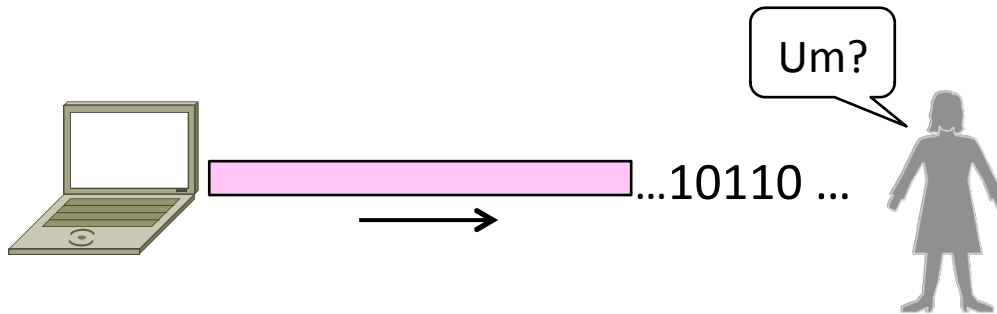

Framing Methods

- We'll look at:
 - Byte count (motivation)
 - Byte stuffing
 - Bit stuffing
- In practice, the physical layer often helps to identify frame boundaries
 - E.g., Ethernet, 802.11

Byte Count

- First try:
 - Let's start each frame with a length field!
 - It's simple, and hopefully good enough ...

Byte Count (2)

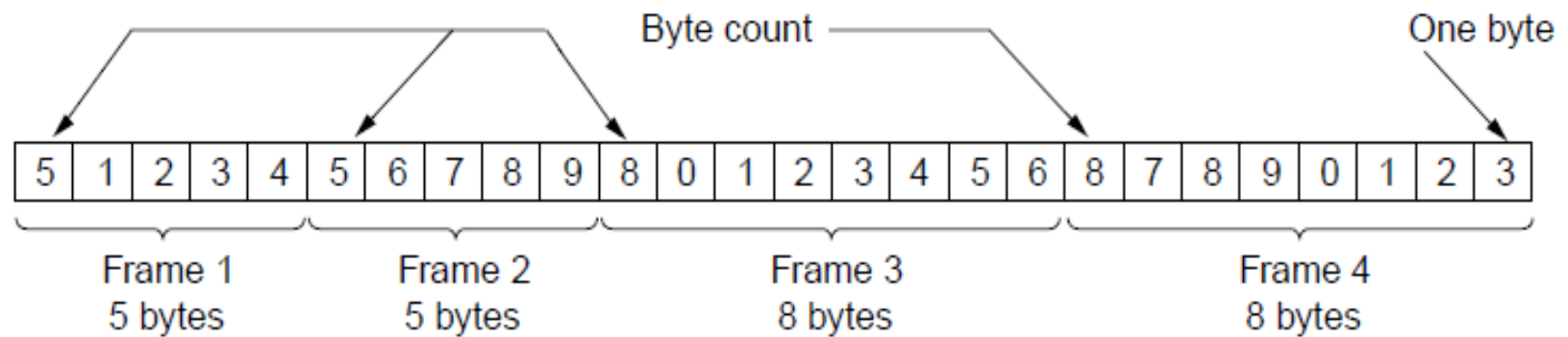

- How well do you think it works?

Byte Count (3)

- Difficult to re-synchronize after framing error
 - Want a way to scan for a start of frame

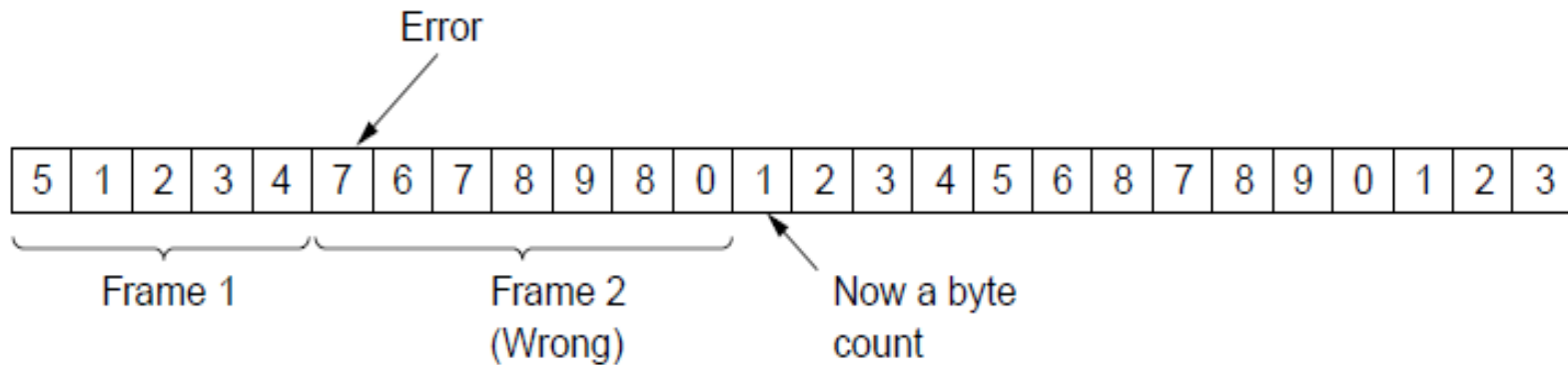

Byte Stuffing

- Better idea:
 - Have a special flag byte value that means start/end of frame
 - Replace (“stuff”) the flag inside the frame with an escape code
 - Complication: have to escape the escape code too!

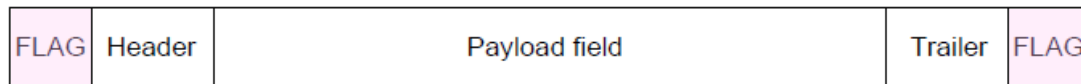

Byte Stuffing (2)

- Rules:
 - Replace each FLAG in data with ESC FLAG
 - Replace each ESC in data with ESC ESC

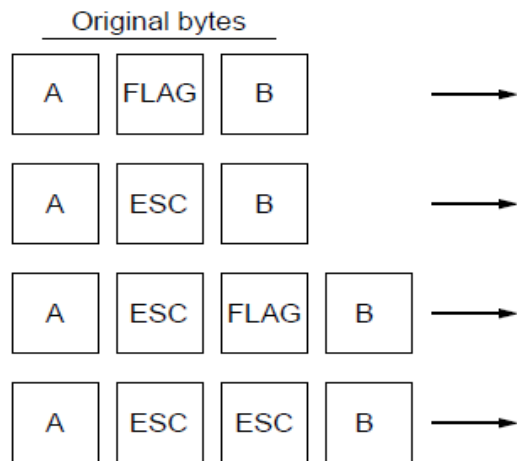

Byte Stuffing (3)

- Now any unescaped FLAG is the start/end of a frame

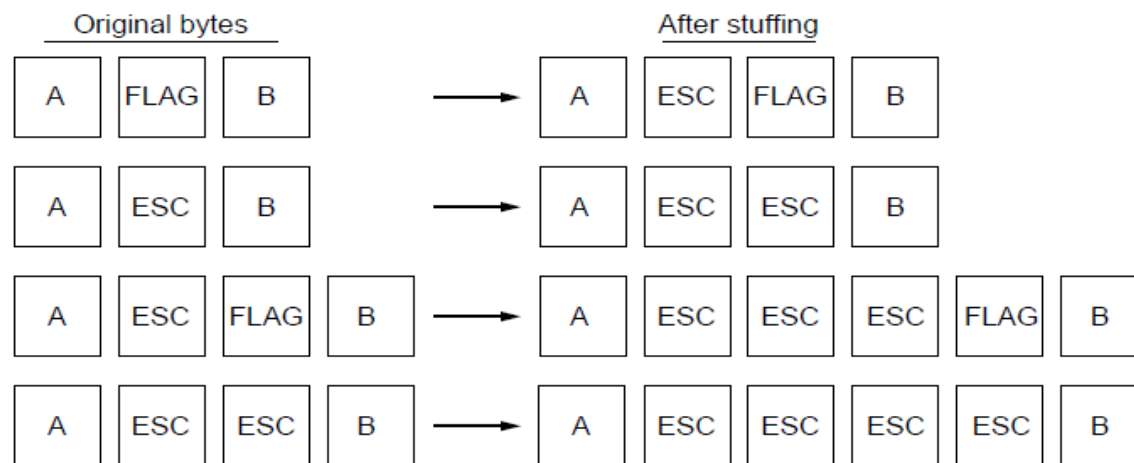

Bit Stuffing

- Can stuff at the bit level too
 - Call a flag six consecutive 1s
 - On transmit, after five 1s in the data, insert a 0
 - On receive, a 0 after five 1s is deleted

Bit Stuffing (2)

- Example:

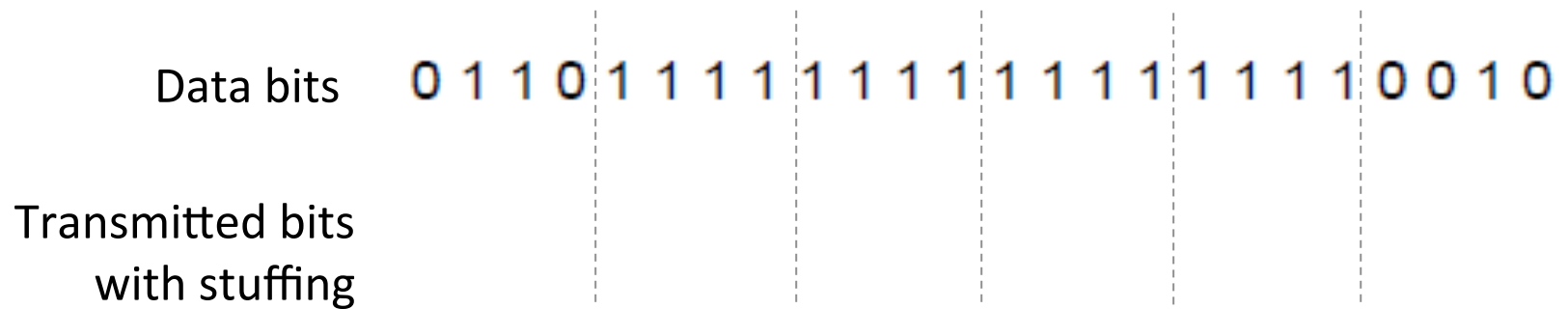

Link Example: PPP over SONET

- PPP is Point-to-Point Protocol
- Widely used for link framing
 - E.g., it is used to frame IP packets that are sent over SONET optical links

Link Example: PPP over SONET (2)

- Think of SONET as a bit stream, and PPP as the framing that carries an IP packet over the link

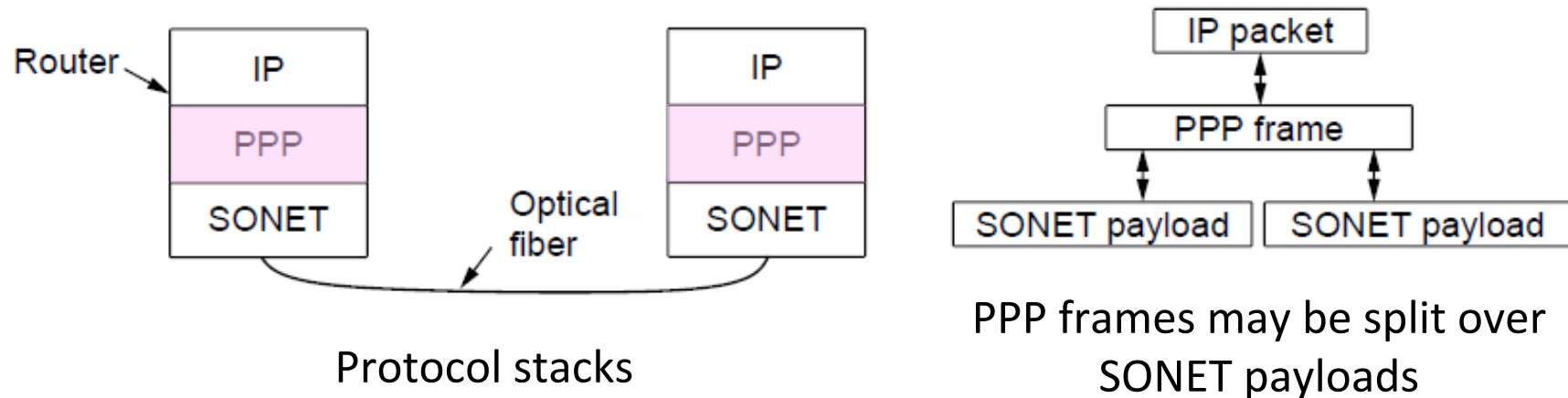

Link Example: PPP over SONET (3)

- Framing uses byte stuffing
 - FLAG is 0x7E and ESC is 0x7D

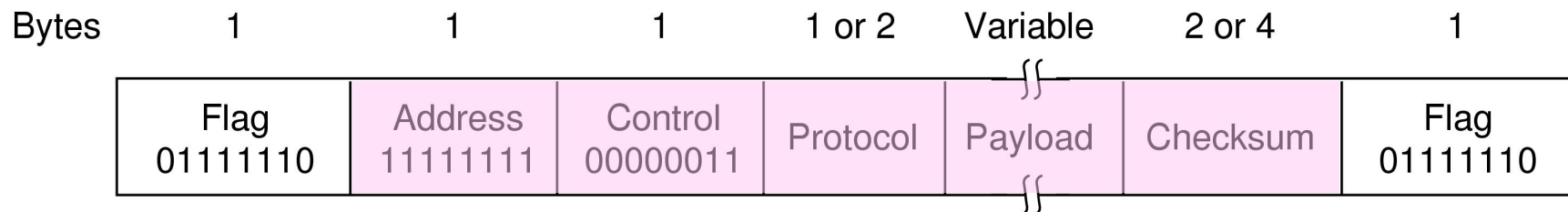

Link Example: PPP over SONET (4)

- Byte stuffing method:
 - To stuff (unstuff) a byte, add (remove) ESC (0x7D), and XOR byte with 0x20
 - Removes FLAG from the contents of the frame

Error Coding Overview (§3.2)

- Some bits will be received in error due to noise. What can we do?
 - Detect errors with codes
 - Correct errors with codes
 - Retransmit lost frames ← Later
- Reliability is a concern that cuts across the layers – we'll see it again

Problem – Noise may flip received bits

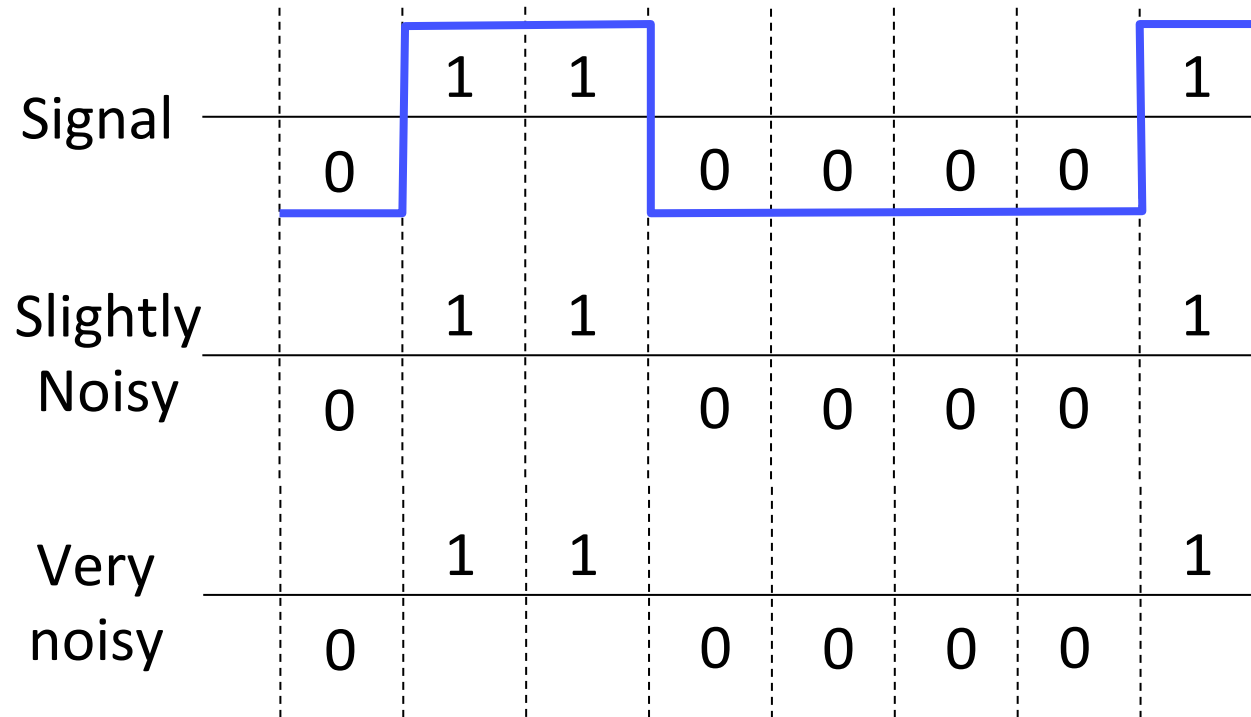

Approach – Add Redundancy

- Error detection codes
 - Add check bits to the message bits to let some errors be detected
- Error correction codes
 - Add more check bits to let some errors be corrected
- Key issue is now to structure the code to detect many errors with few check bits and modest computation

Motivating Example

- A simple code to handle errors:
 - Send two copies! Error if different.
- How good is this code?
 - How many errors can it detect/correct?
 - How many errors will make it fail?

Motivating Example (2)

- We want to handle more errors with less overhead
 - Will look at better codes; they are applied mathematics
 - But, they can't handle all errors
 - And they focus on accidental errors (will look at secure hashes later)

Using Error Codes

- Codeword consists of D data plus R check bits (=systematic block code)

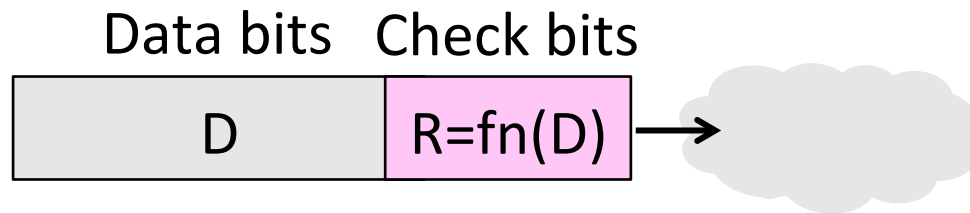

- Sender:
 - Compute R check bits based on the D data bits; send the codeword of D+R bits

Using Error Codes (2)

- Receiver:
 - Receive $D+R$ bits with unknown errors
 - Recompute R check bits based on the D data bits; error if R doesn't match R'

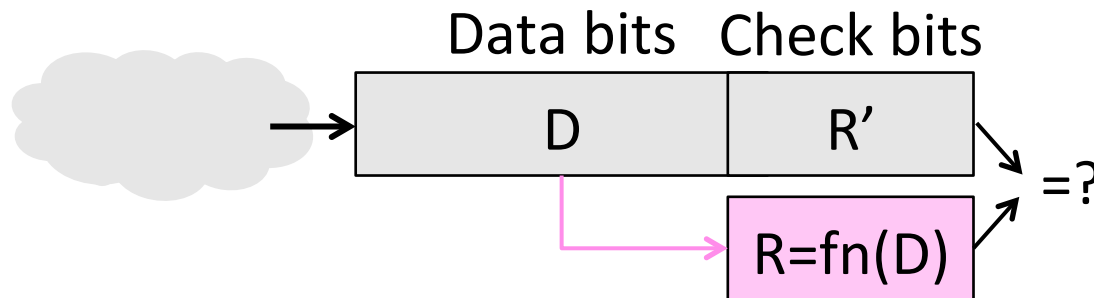

Intuition for Error Codes

- For D data bits, R check bits:

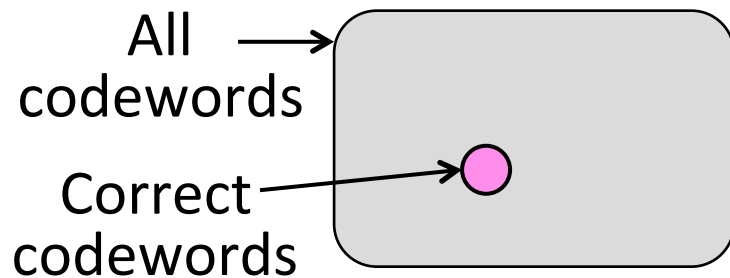

- Randomly chosen codeword is unlikely to be correct; overhead is low

R.W. Hamming (1915-1998)

- Much early work on codes:
 - “Error Detecting and Error Correcting Codes”, BSTJ, 1950
- See also:
 - “You and Your Research”, 1986

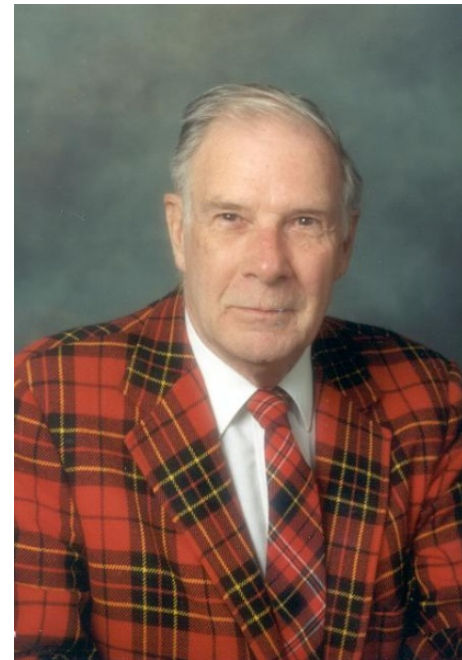

Source: IEEE GHN, © 2009 IEEE

Hamming Distance

- Distance is the number of bit flips needed to change $D+R_1$ to $D+R_2$
- Hamming distance of a code is the minimum distance between any pair of codewords

Hamming Distance (2)

- Error detection:
 - For a code of distance $d+1$, up to d errors will always be detected

Hamming Distance (3)

- Error correction:
 - For a code of distance $2d+1$, up to d errors can always be corrected by mapping to the closest codeword

Error Detection (§3.2.2)

- Some bits may be received in error due to noise. How do we detect this?
 - Parity
 - Checksums
 - CRCs
- Detection will let us fix the error, for example, by retransmission (later).

Simple Error Detection – Parity Bit

- Take D data bits, add 1 check bit that is the sum of the D bits
 - Sum is modulo 2 or XOR

Parity Bit (2)

- How well does parity work?
 - What is the distance of the code?
 - How many errors will it detect/correct?
- What about larger errors?

Checksums

- Idea: sum up data in N-bit words
 - Widely used in, e.g., TCP/IP/UDP



- Stronger protection than parity

Internet Checksum

- Sum is defined in 1s complement arithmetic (must add back carries)
 - And it's the negative sum
- *“The checksum field is the 16 bit one's complement of the one's complement sum of all 16 bit words ...”* – RFC 791

Internet Checksum (2)

Sending:

1. Arrange data in 16-bit words
2. Put zero in checksum position, add
3. Add any carryover back to get 16 bit
4. Negate (complement) to get sum

0001
f203
f4f5
f6f7

Internet Checksum (3)

Sending:

1. Arrange data in 16-bit words
2. Put zero in checksum position, add
3. Add any carryover back to get 16 bits
4. Negate (complement) to get sum

```
0001
f203
f4f5
f6f7
+ (0000)
-----
2ddf0
  ↓
ddf0
+   2
-----
ddf2
  ↓
220d
```

Internet Checksum (4)

Receiving:

1. Arrange data in 16-bit words

2. Checksum will be non-zero, add

3. Add any carryover back to get 16 bits

4. Negate the result and check it is 0

```
0001
f203
f4f5
f6f7
+ 220d
-----
```

Internet Checksum (5)

Receiving:

1. Arrange data in 16-bit words

2. Checksum will be non-zero, add

3. Add any carryover back to get 16 bits

4. Negate the result and check it is 0

```
0001
f203
f4f5
f6f7
+ 220d
-----
2fffd
  ↓
 fffd
+    2
-----
ffff
  ↓
0000
```

Internet Checksum (6)

- How well does the checksum work?
 - What is the distance of the code?
 - How many errors will it detect/correct?
- What about larger errors?

Cyclic Redundancy Check (CRC)

- Even stronger protection
 - Given n data bits, generate k check bits such that the $n+k$ bits are evenly divisible by a generator C
- Example with numbers:
 - $n = 302$, $k = \text{one digit}$, $C = 3$

CRCs (3)

- Send Procedure:
 1. Extend the n data bits with k zeros
 2. Divide by the generator value C
 3. Keep remainder, ignore quotient
 4. Adjust k check bits by remainder
- Receive Procedure:
 1. Divide and check for zero remainder

CRCs (4)

Data bits:
1101011111

1 0 0 1 1 | 1 1 0 1 0 1 1 1 1 1

Check bits:
 $C(x) = x^4 + x^1 + 1$
 $C = 10011$
 $k = 4$

CRCs (5)

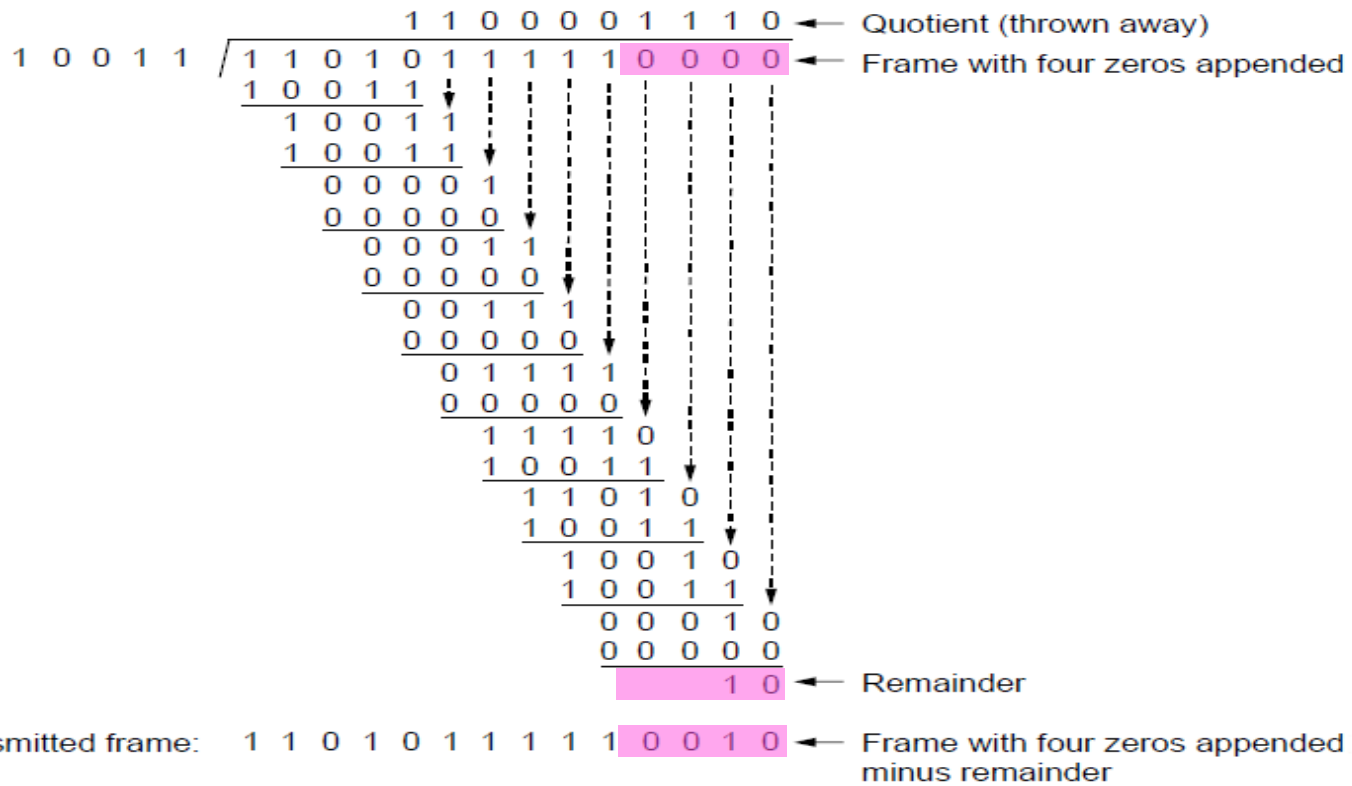

CRCs (6)

- Protection depend on generator
 - Standard CRC-32 is 1 0000 0100 1100 0001 0001 1101 1011 0111
- Properties:
 - HD=4, detects up to triple bit errors
 - Also odd number of errors
 - And bursts of up to k bits in error
 - Not vulnerable to systematic errors like checksums

Error Detection in Practice

- CRCs are widely used on links
 - Ethernet, 802.11, ADSL, Cable ...
- Checksum used in Internet
 - IP, TCP, UDP ... but it is weak
- Parity
 - Is little used

Error Correction (§3.2.1)

- Some bits may be received in error due to noise. How do we fix them?
 - Hamming code
 - Other codes
- And why should we use detection when we can use correction?

Why Error Correction is Hard

- If we had reliable check bits we could use them to narrow down the position of the error
 - Then correction would be easy
- But error could be in the check bits as well as the data bits!
 - Data might even be correct

Intuition for Error Correcting Code

- Suppose we construct a code with a Hamming distance of at least 3
 - Need ≥ 3 bit errors to change one valid codeword into another
 - Single bit errors will be closest to a unique valid codeword
- If we assume errors are only 1 bit, we can correct them by mapping an error to the closest valid codeword
 - Works for d errors if $HD \geq 2d + 1$

Intuition (2)

- Visualization of code:

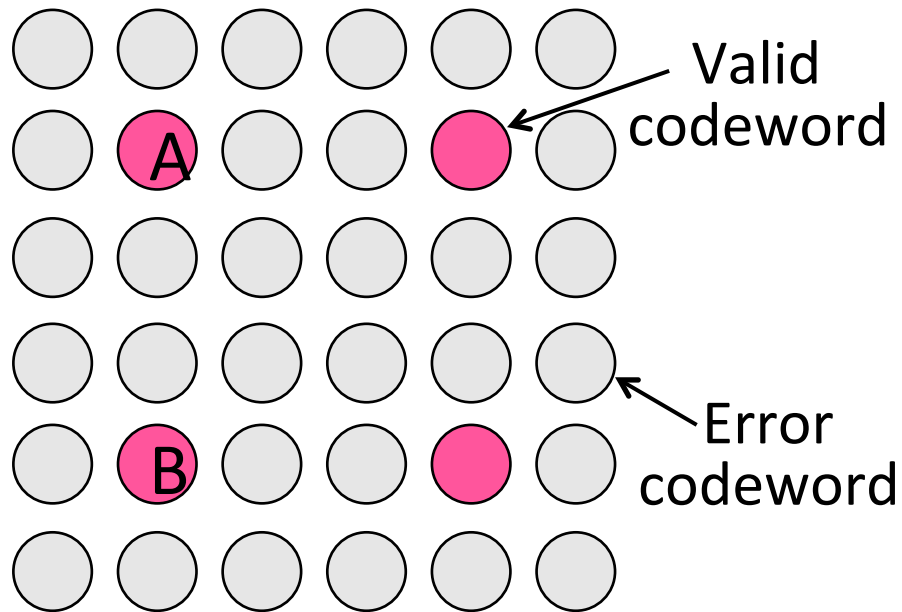

Intuition (3)

- Visualization of code:

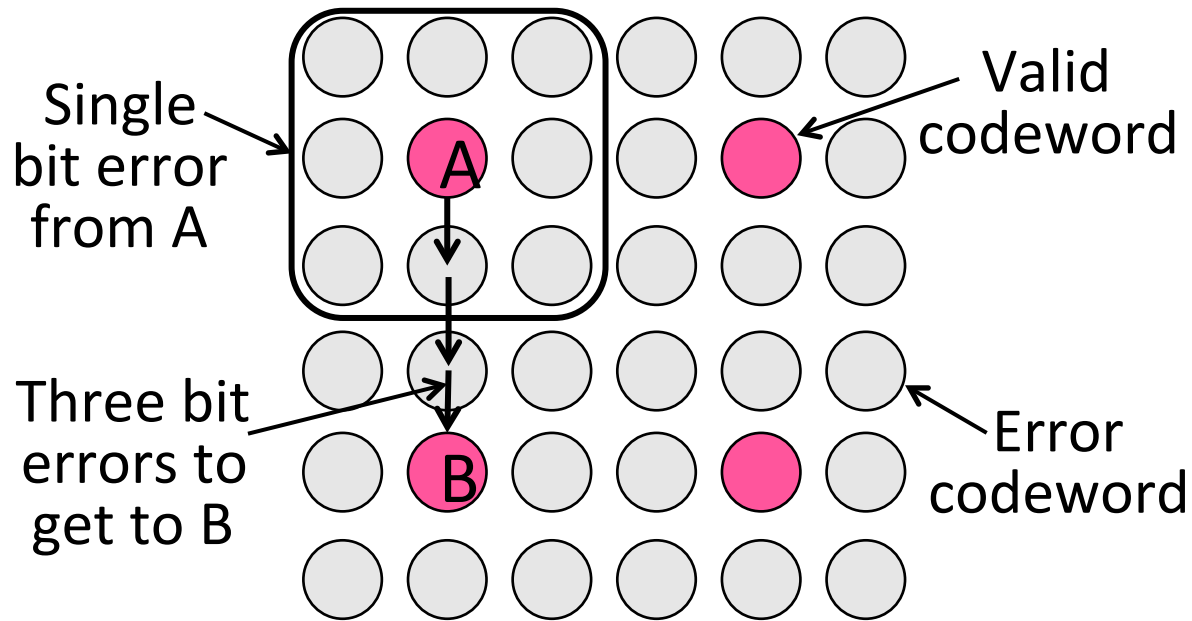

Hamming Code

- Gives a method for constructing a code with a distance of 3
 - Uses $n = 2^k - k - 1$, e.g., $n=4, k=3$
 - Put check bits in positions p that are powers of 2, starting with position 1
 - Check bit in position p is parity of positions with a p term in their values
- Plus an easy way to correct [soon]

Hamming Code (2)

- Example: data=0101, 3 check bits
 - 7 bit code, check bit positions 1, 2, 4
 - Check 1 covers positions 1, 3, 5, 7
 - Check 2 covers positions 2, 3, 6, 7
 - Check 4 covers positions 4, 5, 6, 7

1 2 3 4 5 6 7

Hamming Code (3)

- Example: data=0101, 3 check bits
 - 7 bit code, check bit positions 1, 2, 4
 - Check 1 covers positions 1, 3, 5, 7
 - Check 2 covers positions 2, 3, 6, 7
 - Check 4 covers positions 4, 5, 6, 7

0 1 0 0 1 0 1 →
1 2 3 4 5 6 7

$$p_1 = 0 + 1 + 1 = 0, \quad p_2 = 0 + 0 + 1 = 1, \quad p_4 = 1 + 0 + 1 = 0$$

Hamming Code (4)

- To decode:
 - Recompute check bits (with parity sum including the check bit)
 - Arrange as a binary number
 - Value (syndrome) tells error position
 - Value of zero means no error
 - Otherwise, flip bit to correct

Hamming Code (5)

- Example, continued

→ 0 1 0 0 1 0 1
1 2 3 4 5 6 7

$p_1 =$

$p_2 =$

$p_4 =$

Syndrome =

Data =

Hamming Code (6)

- Example, continued

→ $\underline{0} \ \underline{1} \ 0 \ \underline{0} \ 1 \ 0 \ 1$
1 2 3 4 5 6 7

$$p_1 = 0+0+1+1 = 0, \quad p_2 = 1+0+0+1 = 0,$$

$$p_4 = 0+1+0+1 = 0$$

Syndrome = 000, no error

Data = 0 1 0 1

Hamming Code (7)

- Example, continued

→ 0 1 0 0 1 1 1
1 2 3 4 5 6 7

$p_1 =$

$p_2 =$

$p_4 =$

Syndrome =

Data =

Hamming Code (8)

- Example, continued

→ $\underline{0} \ \underline{1} \ 0 \ \underline{0} \ 1 \ 1 \ 1$
1 2 3 4 5 6 7

$$p_1 = 0+0+1+1 = 0, \quad p_2 = 1+0+1+1 = 1,$$

$$p_4 = 0+1+1+1 = 1$$

Syndrome = 1 1 0, flip position 6

Data = 0 1 0 1 (correct after flip!)

Other Error Correction Codes

- Codes used in practice are much more involved than Hamming
- Convolutional codes (§3.2.3)
 - Take a stream of data and output a mix of the recent input bits
 - Makes each output bit less fragile
 - Decode using Viterbi algorithm (which can use bit confidence values)

Other Codes (2) – LDPC

- Low Density Parity Check (§3.2.3)
 - LDPC based on sparse matrices
 - Decoded iteratively using a belief propagation algorithm
 - State of the art today
- Invented by Robert Gallager in 1963 as part of his PhD thesis
 - Promptly forgotten until 1996 ...

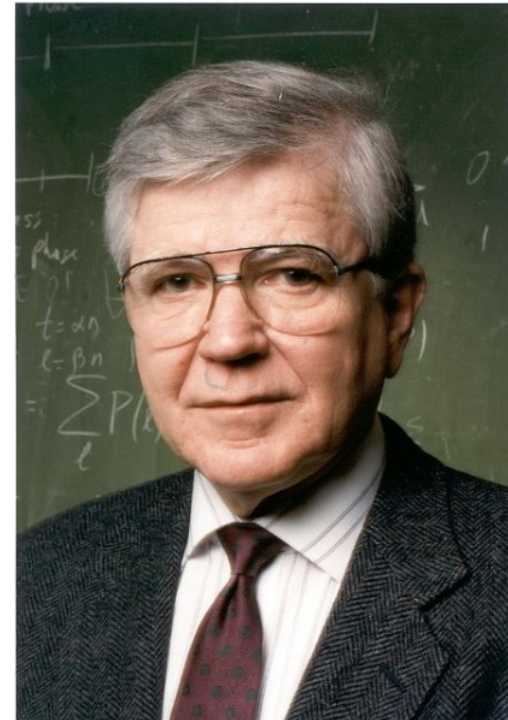

Source: IEEE GHN, © 2009 IEEE

Detection vs. Correction

- Which is better will depend on the pattern of errors. For example:
 - 1000 bit messages with a bit error rate (BER) of 1 in 10000
- Which has less overhead?

Detection vs. Correction

- Which is better will depend on the pattern of errors. For example:
 - 1000 bit messages with a bit error rate (BER) of 1 in 10000
- Which has less overhead?
 - It still depends! We need to know more about the errors

Detection vs. Correction (2)

1. Assume bit errors are random
 - Messages have 0 or maybe 1 error
- Error correction:
 - Need ~10 check bits per message
 - Overhead:
- Error detection:
 - Need ~1 check bits per message plus 1000 bit retransmission 1/10 of the time
 - Overhead:

Detection vs. Correction (3)

2. Assume errors come in bursts of 100
 - Only 1 or 2 messages in 1000 have errors
- Error correction:
 - Need $\gg 100$ check bits per message
 - Overhead:
- Error detection:
 - Need 32? check bits per message plus 1000 bit resend 2/1000 of the time
 - Overhead:

Detection vs. Correction (4)

- Error correction:
 - Needed when errors are expected
 - Or when no time for retransmission
- Error detection:
 - More efficient when errors are not expected
 - And when errors are large when they do occur

Error Correction in Practice

- Heavily used in physical layer
 - LDPC is the future, used for demanding links like 802.11, DVB, WiMAX, LTE, power-line, ...
 - Convolutional codes widely used in practice
- Error detection (w/ retransmission) is used in the link layer and above for residual errors
- Correction also used in the application layer
 - Called Forward Error Correction (FEC)
 - Normally with an erasure error model
 - E.g., Reed-Solomon (CDs, DVDs, etc.)